

TEKNISK DATABLAD



Dykkert type: F18 (18 GAUGE) Rett Dykkert
 Diameter: 1,20 mm







Passer til følgende verktøy*:

Paslode FN1835, FN1850, IM50 F18
 Haubold SKN30 JN/12, SKN40 I/12, SKN40 L-I/12, SKN50 L/12, SKN50 L-1/12
 Duo-Fast FN4455, K4440A, K4440AGL

*sjekk dykkertlengde mot verktøy før bruk

Dykkertlengde: 15mm - 50mm
 Dykkert pr. strip: 50

KORROSJONSBESKYTTELSE

Overflate	Bruksområde	Fargekode
Elforsinket 1-2µm 7-15g/m ²	 INNENDØRS BRUK	 Blå
Rustfritt stål A2 AISI 304 / Wnr 1.4301	 INNENDØRS, BESKYTTET UTENDØRS & UTENDØRS BRUK	 Gul
Rustfritt stål A4 AISI 316 / Wnr 1.4401	 INNENDØRS, BESKYTTET UTENDØRS & UTENDØRS BRUK	 Gul

KORROSJONSBESKYTTELSE

Strekfasthet: Min 950N/mm²
 Diameter (d): 1,20 mm
 Dimensjon: (A) 1,00 mm
 (B) 1,25 mm
 Hodehøyde (D): 1,90 mm
 Hodebredde (C): 1,000 mm
 Strip lengde (Lp): 50 dykkert
 Standard punkt: Diamant 80°
 Standard dykkert lengde (Lh): 15 mm - 50 mm

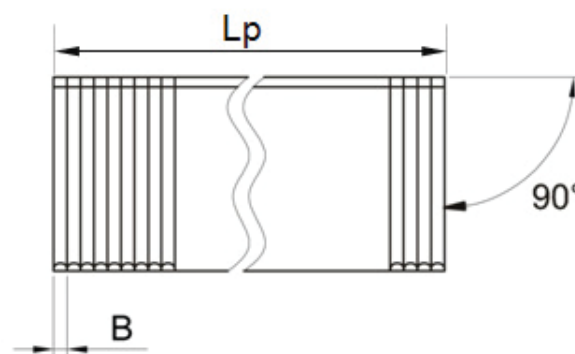
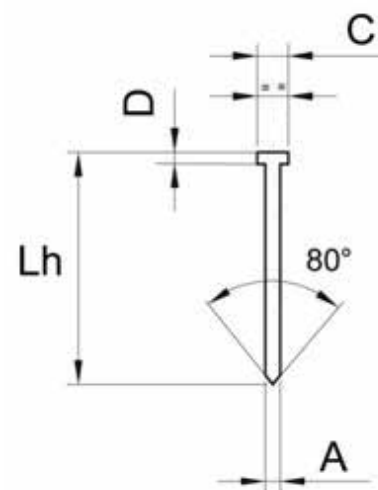

TILGJENGELIGE DYKKERT LENGDER*

Overflate	Tilgjengelige lengder
Elforsinket 1-2µm 7-15g/m ²	* sjekk tilgjengelighet i Produktkatalogen 15mm, 16mm, 19mm, 25mm, 32mm, 35mm, 38mm, 40mm, 45mm, 50mm
Rustfritt stål A2 AISI 304 / Wnr 1.4301	20mm, 25mm, 30mm, 35mm, 40mm
Rustfritt stål A4 AISI 316 / Wnr 1.4401	20mm, 25mm, 30mm, 35mm